

motionCAT *series*

 株式会社 **ハイバーテック**
[http://www hivertec co jp/](http://www.hivertec.co.jp/)

Microsoft Microsoft Corporation

Windows Windows 98 Windows NT 4.0 Windows 2000 Windows XP Windows Vista Windows 7 Microsoft Corporation

Visual Studio Visual Basic Visual C# Visual C++ Microsoft Corporation

.NET Framework Microsoft Corporation

1-8-11

TEL 03-3846-3801
FAX 03-3846-3773
sales@hivertec.co.jp

1 30 2010 6 23

1.

- 1. 1
- 1.1 2
- 1.2 2
- 1.3 3
 - 1.3.1 3
 - 1.3.2 Bus 3
 - 1.3.3 4
 - 1.3.4 4
 - 1.3.5 5
 - 1.3.6 6
 - 1.3.7 6
 - 1.3.8 7
- 1.4 7
 - 1.4.1 motionCAT 7
 - 1.4.2 motionCAT 7
 - 1.4.3 7
- 1.5 7
- 2. 8
 - 2.1 9
 - 2.1.1 9
 - 2.1.2 9
 - 2.1.3 9
 - 2.1.4 10
 - 2.1.5 10
 - 2.1.6 11
 - 2.1.7 11
 - 2.1.8 11
 - 2.1.9 12
 - 2.1.10 13
 - 2.1.11 16
 - 2.2 motionCAT 17
 - 2.2.1 17
 - 2.2.2 LSI 18
 - 2.2.3 18
 - 2.2.4 18
 - 2.2.5 18
 - 2.2.6 18
 - 2.2.7 ID 19
 - 2.2.8 19
 - 2.2.9 19
 - 2.2.10 20
- 3. motionCAT 21
 - 3.1 motionCAT 22
 - 3.2 motionCAT 22
 - 3.3 22

3.4	23
3.5	24
3.6	25
3.7	25
3.7.1	25
3.7.2	25
3.7.3	25
3.7.4	26
3.7.5	26
3.7.6	26
4. motionCAT	27
4.1 HPCI-MCAT520M	28
4.1.1	28
4.1.2	28
4.1.3	29
4.1.4	29
4.1.5	30
4.2 HCPCI-MNT720M	31
4.2.1	31
4.2.2	31
4.2.3	32
4.2.4	32
4.2.5	33
4.3 HPC104-MCAT110M	34
4.3.1	34
4.3.2	35
4.3.3	36
4.3.4	39
4.3.5	41
4.4 HM-GU00T	42
4.4.1	42
4.4.2	42
4.4.3	42
4.4.4	43
4.4.5	44
5. motionCAT	45
5.1	46
5.1.1	46
5.1.1 HMG	47
5.1.2 HUG	48
5.1.3 24	49
5.2	50
5.2.1 1 (P) HM-P100C	50
5.2.2 DIO (D) HM-D1616C	51
5.2.3 DIO (T) HM-D2408T	51
5.3	52
5.3.1	52
5.3.2	53
5.3.3 DIO	53
5.3.4	53
5.4	54
5.5	57
5.5.1	57
5.5.2	58
5.6 (P) HM-P100C	59
5.6.1	59
5.6.2	60

5.6.3	61
5.6.4	62
5.6.5	63
5.6.6	65
5.7 DIO (D) HM-D1616C	67
5.7.1	67
5.7.2	68
5.7.3	69
5.8 DIO (T) HM-D2408T	70
5.8.1	70
5.8.2	71
5.8.3	71
5.8.4	71
6.	72
6.1 ACB-TH2408	73
6.2 ACB-TH1204	73
7.	74
7.1 HPCI-MCAT520M, HCPCI-MNT720M	75
7.1.1 Windows 7 Vista(32)	75
7.1.2 Windows 7 Vista(64)	75
7.1.3 Windows XP	75
7.1.4 Windows 2000	75
7.1.5 Windows 7 Vista XP (2.0.0.0)	75
7.1.6 Windows 2000 (1.0.0.1)	76
7.1.7	76
7.2 HPC104-MCAT110M	77
7.2.1 Windows	77
7.2.2 Windows	77
7.3 HM-GU00T	78
7.3.2 Windows 7 Vista(32)	78
7.3.3 Windows 7 Vista(64)	78
7.3.4 Windows XP	78
7.3.5	78
8.	79
8.1	80
8.2	80
8.3	80
8.4	80
8.5 HPCI-MCAT520M, HCPCI-MNT720M	81
8.5.1	81
8.5.2	81
8.5.3 DIO	84
8.6 HPC104-MCAT110M	84
8.6.1	85
8.6.2	85
8.7 HM-GU00T	86
8.7.1	86
8.7.2	86
8.7.3	87
8.7.4	87
8.7.5 DIO (D1616)	97
8.7.6 DIO (D2408)	98
8.8	99
9.	100
9.1	101
9.2 MELSERVO MR-J3	102
9.3 MINAS-A4	103

9.4 AD3 104
9.5 STEP 105
9.6 (PMU,UMK SD51xx,DFC) 106
9.7 106
10. 107

1.

1.1

1

3

2

2

1.2

1

2

A A

3

4

1.3

NC

1.3.1

1.3.2 Bus

HPCI-MCAT520M	PCI Local Bus Specification Rev 2 2
	PCI Local Bus Specification Rev 2 2
HCPCI-MNT720M	CompactPCI Specification Revision 2 1
	CompactPCI Specification Revision 2 1
HPC104-MCAT110M	PC/104 Bus Ver2 5
	PC/104 Bus Ver2 5
HM-GU00T	Universal Serial Bus 2 0 High Speed
USB2 0	USB1 1

1.3.3

'	0	+50		
'	20%RH	85%RH()
'	-15	+75		
'	10%RH	90%RH()
'				
'		3000m	(300m	2)

1.3.4

Motionnet				
	LAN	CAT5e		
		60		
			50	
1		32		33
1				
	ID	ID		

1.3.5

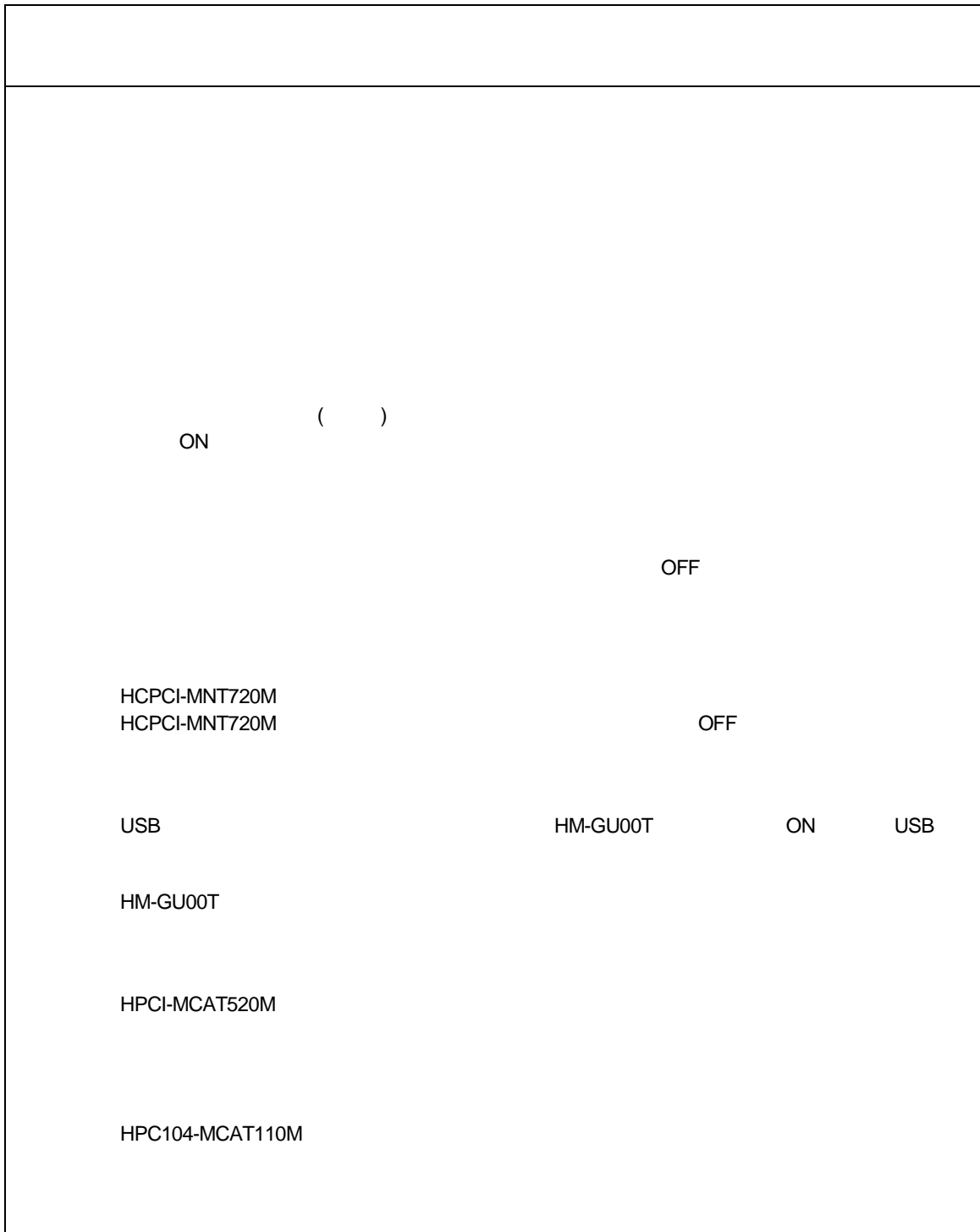

1.3.6

OFF
A

1.3.7

1.3.8

1.4

motionCAT
' motionCAT
' motionCAT
,

1.4.1 motionCAT

(1)
(2)
(3) motionCAT
(4)
(5)
(6)
(7)
(8)
(9)
(1) (3),(7),(8) motionCAT
(4) (6),(9)

1.4.2 motionCAT

motionCAT
(1)
(2)
(3)

1.4.3

(1)
(2)
(3)
(4)
(5)
(6)

1.5

motionCAT Windows
(1) Windows
(2)
(3) Microsoft Visual Studio

2.

2.1

2.1.1

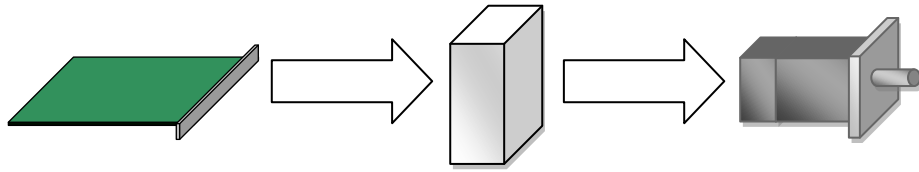

2.1.2

1. ()

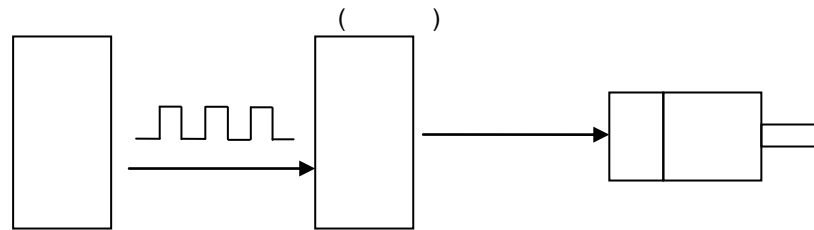

2.

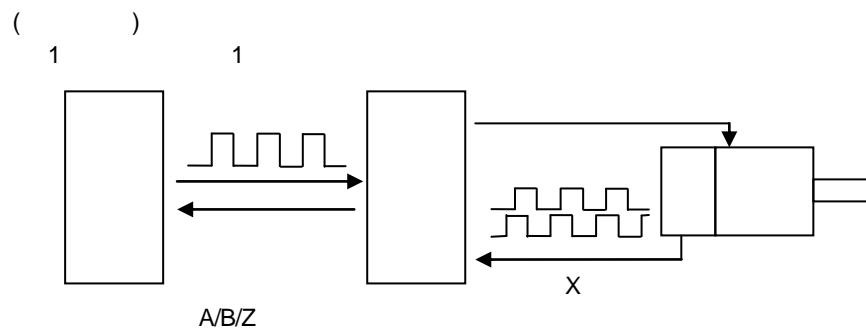

2.1.3

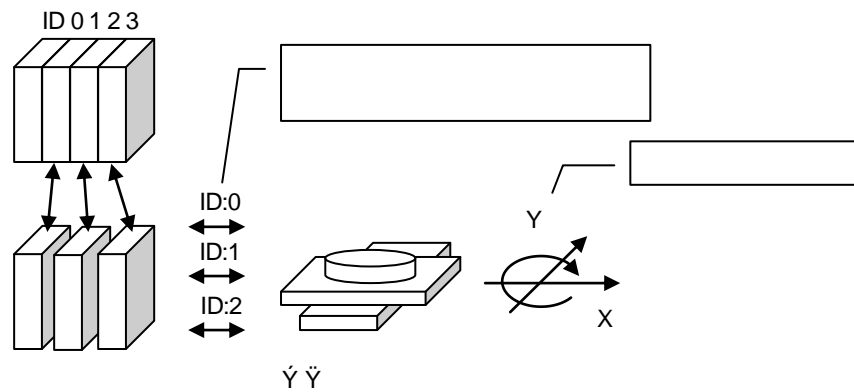

2.1.4



(pulse
(pps)

1

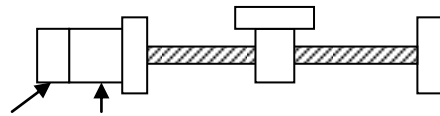

$= 10(\text{mm})$ $1000(\text{p/r})$
 $10(\text{mm})$ 1 $10(\text{mm})$
 1 1000 1
 $10/1000(\text{mm}) = 0.01(\text{mm})$
 1mm $1/0.01 = 100$

 1
 1 $0.01(\text{mm})$ $1(\text{pps}) = 0.01(\text{mm/sec})$
 10mm/sec $10/0.01 = 1000(\text{pps})$

2.1.5

(1)

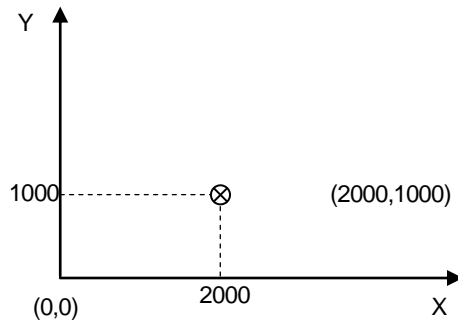

(2)

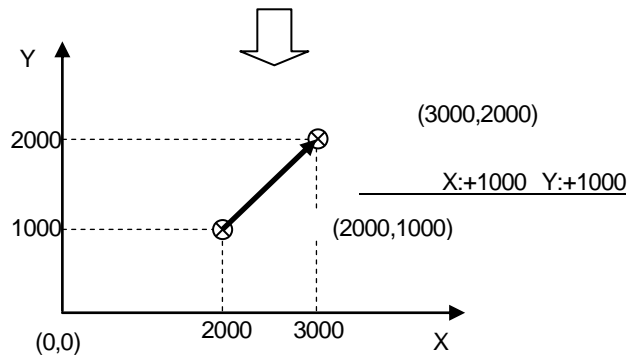

2.1.6

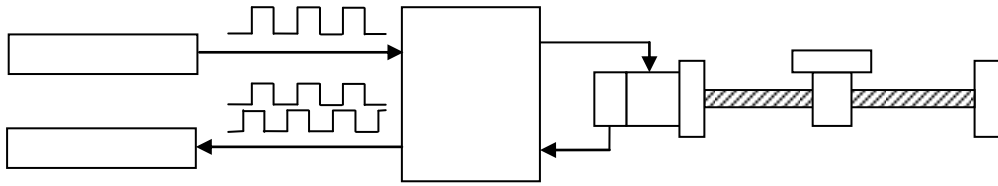

2.1.7

(1)

(2)

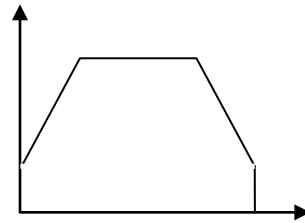
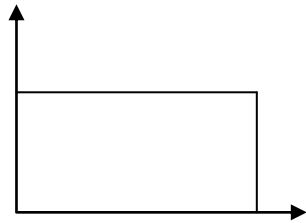

2.1.8

(1)

(2)

(3)

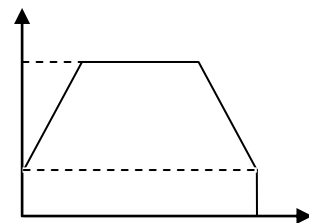

2.1.9

(1)

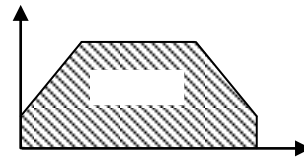
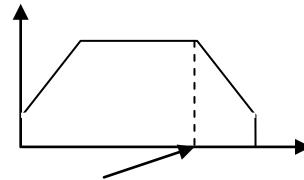

CE OLS(OLS ON)

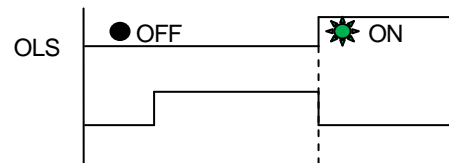

CE OLS+Z OLS ON Z

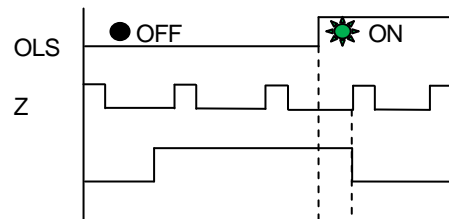

CE ELS(ELS ON) UP UØØ

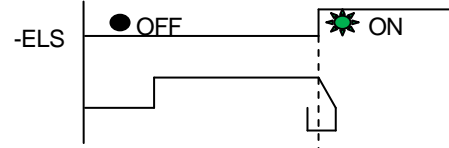

SVALM

INPOS

COIN

SVRDY

ON

FB

Z (C)

1

A B

A B Z

CE CW

A B "Low"

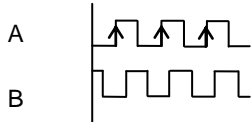

CE CCW

A B "High"

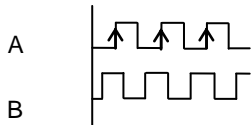

CE

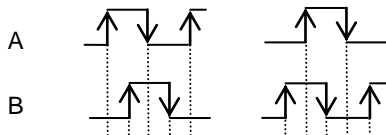

1	+	+	-	B	Low	A
2	+	+	-	A		
4	+++++		-----	A		B

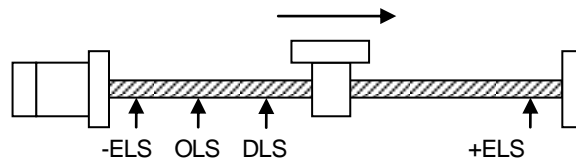

ELS(Stroke End-Limit Sensor, OT)

ELS

ELS ()

OLS(Origin-Limit Sensor Z ()

DLS(Deceleration-Limit Sensor)

1. CMP()

()
LATCH()
LATCH

CLR()
CLR

2.1.11

(2)

(3)

3

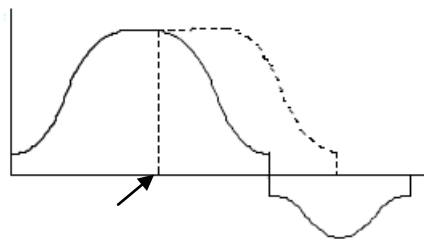
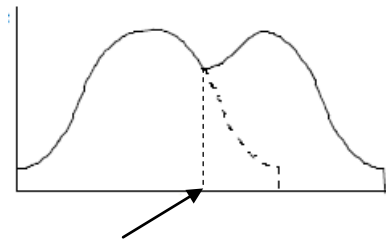
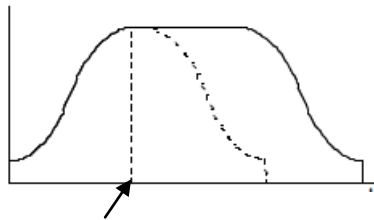

(4)

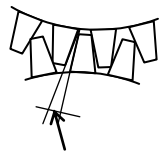

(5)

2.2 motionCAT

2.2.1

motionCAT											
1						G9001A	2		2		
				1	6						
1		1				G9003	1				
1	DIO	16IN/16OUT		24IN/8OUT	I/O	DIO		G9002	1		
					DIO						

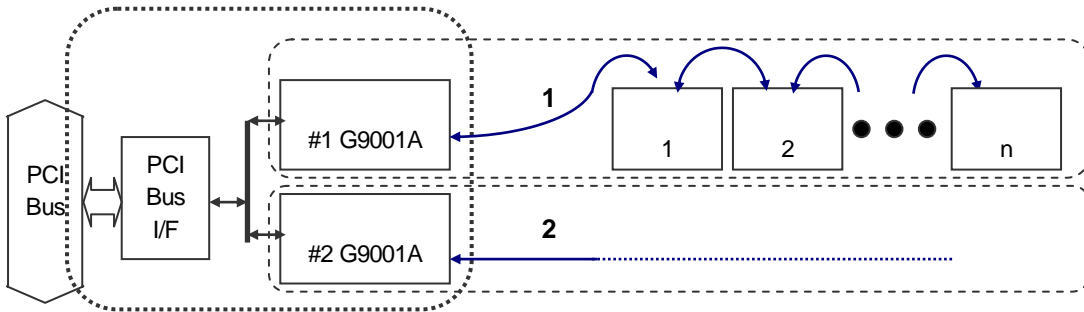

2.2-1 motionCAT

(1) HMG

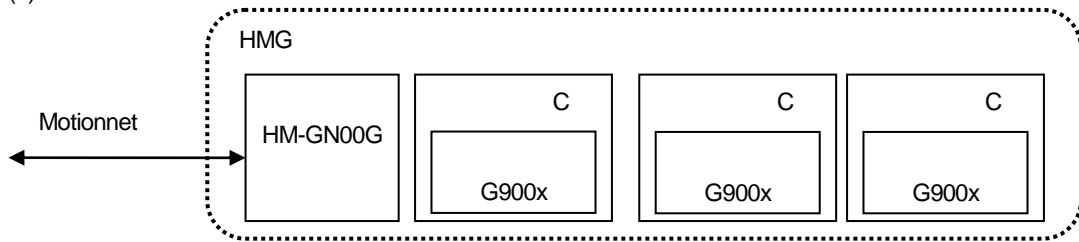

2.2-2 HMG

(2) HMG

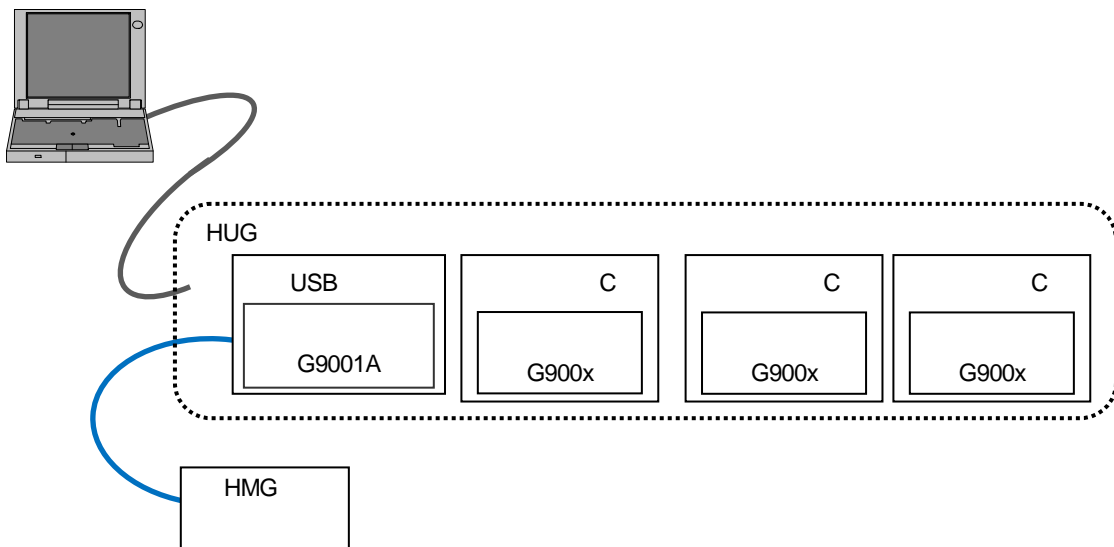

2.2-3 HUG

(3)

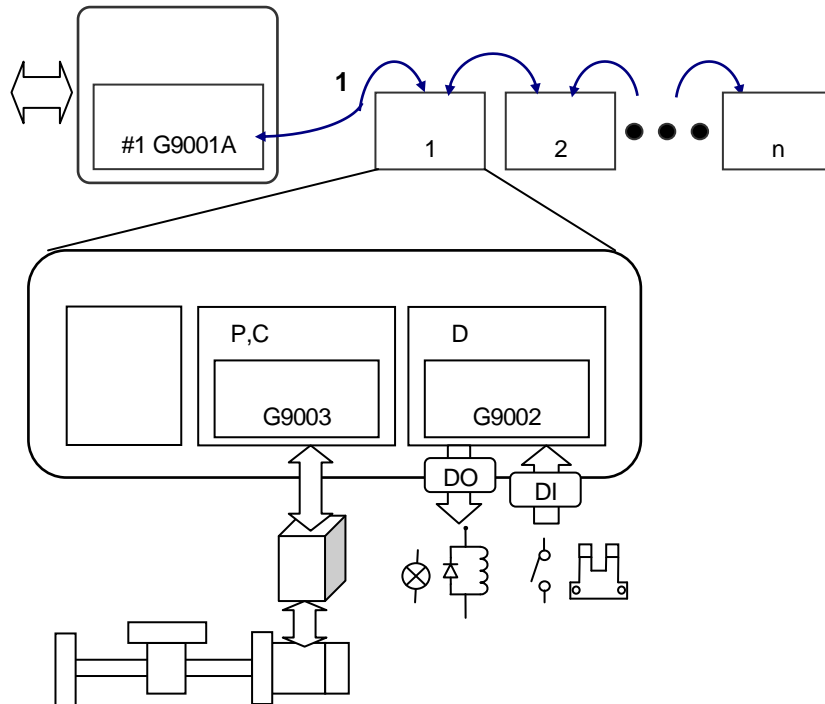

2.2.2 LSI

(G9001A)
(G9003)

DIO (G9002)

		G9001A	1	
		G9003	1	()
		G9103A		
	DIO	G9002	4	I/O

2.2-1

2.2.3

motionCAT

2.2.4

2.2.5

(1 6)

HMG HUG

2.2.6

ID (P C) DIO(D T) (A)
ID 00h 3Fh(0 63)

